

MONORAIL SYSTEMS

MAINTENANCE EQUIPMENT
window washing systems

11010
3 04

Pro-Bel Enterprises
Limited



PRO+BEL

Safety Systems Engineered for Life



SUSPENDED EQUIPMENT & FALL PROTECTION EXPERTS

PRO-BEL ENTERPRISES LIMITED

Head Office
765 Westney Rd S,
Ajax ON Canada L1S 6W1

[t] 905.427.0616
[tf] 1.800.461.0575
[f] 905.427.2545
[e] info@pro-bel.ca

Western Office
#103-350, East Kent Ave S
Vancouver, BC Canada V5X 4N6

[t] 604.687.1301
[f] 604.687.1306
[e] infovan@pro-bel.ca

Pro-Bel USA
29320 Union City Blvd,
Union City, CA USA 94587

[t] 510.477.9666
[tf] 1.866.577.6235
[f] 510.477.9555
[e] info@pro-belusa.com

Window Cleaning/
Suspended Maintenance
Equipment & Fall
Protection Systems

USE

Ideal for underside of building overhangs, sloped glazing/skylighting, all types of atrium glass, domes, and similar applications.

Suitable for use with platform, single work cage or bosun's chair.

DESCRIPTION

Pro-Bel monorail systems are often used to access difficult to reach or otherwise inaccessible exterior or interior glass areas. Typically a Pro-Bel monorail system consists of an aluminum rail section which houses a manual or electrically powered traversing trolley (see climbing monorail data on page M-4). Monorails are generally used for platform work and monorail supports are typically secured to the building at 10'-0" to 12'-0" (3050 mm to 3658 mm) intervals. Additional supports are required at corner locations and with curved tracks. For a two person platform, four trolleys are required; two for the primary suspension (platform) and two for the workers' lifelines.

Trolley Types

Pro-Bel monorail systems incorporate various types of trolleys e.g. manual, manual chain drive, motorized, battery operated, and climbing.

Rails, which can be straight or radiused, may be left exposed or concealed in soffit or ceiling spaces. Whatever the application, the platform is slid along the monorail (manual systems). Curved rails are available with a 90° or 45° bend or circle configuration and require a 3'-0" (915 mm) minimum radius.

Typically, workers access monorails via a localized window, hatch, rigging sleeve or ladder. They then suspend their lines from the monorail and return to the first floor or lower level to ground rig their platform. One of the most overlooked items by design professionals is the provision for localized access to the monorail and fall protection for workers while en route.

Gantry systems (permanent platforms on monorails) can be employed for working over glass when all other conventional means of performing maintenance cannot be used.

Rigging sleeves are often used with or as a substitute for monorail where the only option for locating suspension lines or lifelines is *through* a wall, floor or roof. Refer to Rigging Sleeve literature.

Portable hook ladder systems are an efficient, simple alternative to either monorail or gantry systems in many cases.



Workers adjusting new Pro-Bel exterior monorail system which accommodates four trolleys for a two person platform (two for suspension of the platform and two for worker's lifelines). Suspension cable is temporarily secured to the structure above the soffit to facilitate installation. Monorail has been powder coated to match soffit finish. Overlook at Great Notch, Little Falls, N.J.



Access to exterior monorail is achieved via a localized operable window. This worker has a wide spandrel ledge to step onto, however a separate and independent fall arrest system secured to an interior safety anchor is normally required to safely connect to the monorail (continuous protection).



In this soffit application, a Pro-Bel monorail, in addition to accommodating a platform can also be used for direct lanyard application (shown in photo), suspending a bosun's chair, or for securing a vertical lifeline.

Primary Suspension Equipment



Top portion of photo shows a curved screen canopy at the 16th floor level equipped with a Pro-Bel aluminum monorail system which is used to suspend a 30'-0" (9.1 m) 'F' Type platform (4 point suspension). U.S. Courthouse & Federal Building, Sacramento, California.

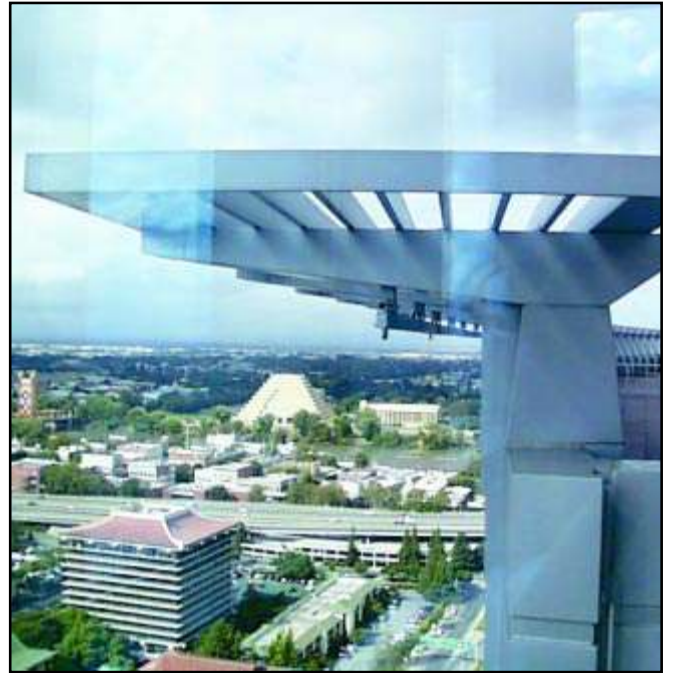

Closeup photo of curved screen canopy showing terminal end of monorail secured to canopy structural supports. Aluminum monorail was factory pre-curved in 12'-0" (3.7 m) sections prior to installation on custom designed hangers.



Pro-Bel aluminum "Halo" monorail provides continuous support for a suspended platform around most of this highrise apartment building, with davits serving the remainder of building. In addition to being functional, the "Halo" adds a certain aesthetic or style to the project. The Pacific Condos, Long Beach, California.

CLIMBING MONORAIL TROLLEYS

Climbing monorail trolleys are designed to traverse along a horizontal, inclined or vertical monorail – even those with twists or curves. They are used to suspended a platform, single work cage or a bosun’s chair.

Climbing monorails trolleys are ideal for sloped interior atria while external applications include curved and sloped building facades.

The Pro-Bel climbing trolley employs two power packs that rely on friction between the trolley wheels and a specially designed aluminum monorail. The trolleys operate safely even on a wet or frosty monorail allowing year round service in most weather conditions.

Trolleys employ a mechanically positive trolley drive system that travels along and up the rail and incorporates an over-speed and secondary brake to prevent uncontrolled movement down an incline due to failure.

Electric power to the trolleys is provided via a busbar system located adjacent to the monorail. Operation is by pendant control operable from the platform, cage or bosun’s chair. Controls are constant pressure type having Forward, Reverse and Emergency Stop buttons.



Platform is suspended from trolleys secured to soffit mounted steel I-beam monorail. Recessed facade at upper level requires platform to be switched from an interior monorail to an exterior monorail and vice versa using a turning hub or “turntable” (see close-up photo below, right). Enron Building 2, Houston, Texas.



Electric powered climbing monorail trolley,



Steel I-beam monorails at turning hub shows battery powered trolleys used for platform “drops” which are plugged into permanent soffit electrical outlets when not in use.



The top of this curved building elevation shows a monorail utilizing electric powered trolleys to pull a platform (not shown) up the incline. See close-up photo of motorized trolley in center of page. Surrey City Centre, Surrey, British Columbia.



Monorail system can also be roof mounted (as shown) or wall mounted, as desired. Both suspension line and lifeline are secured to rolling trolleys. This system is fundamentally different than a typical monorail. This product is actually a horizontal trolley rail system. See Pro-Bel Horizontal Trolley Rail Systems literature.

FEATURES

System versatility; monorail systems are available to suit any aesthetic requirement, building configuration, interior/exterior application, in either manual or automatic systems.

All corrosion resistant materials; exterior rail components are aluminum or hot-dip galvanized steel. All other components e.g. plates, bolts, pins, trolleys and miscellaneous items are hot-dip galvanized steel, stainless steel or aluminum. All exterior supports are hot-dip galvanized steel.

Finish options; in addition to mill and anodized finishes or galvanized finish, exterior aluminum or steel monorails are available with polyester or polyurethane powder coated baked enamel paint finish, color as selected from manufacturer's standard colors, or custom color if desired; interior aluminum or steel paint finishes are offered in epoxy or hybrid powder coated finish, or alternatively may be enamel painted on site.

Standards conformance; all rails and related equipment including trolleys comply with OSHA and ASME/ANSI/IWCA safety requirements for window cleaning, and various materials standards.

Engineer certified; OSHA requires that monorail and gantrys be designed by or under the direction of a registered professional engineer experienced in such design. Pro-Bel monorail and gantry performance is based on data derived from independent testing and/or engineering calculations. Trolleys are rated at minimum 1,000 lb. (4.5 kN) vertical service load.

Compatible with roofing; an important consideration in the design of Pro-Bel monorails is the need to maintain the long term watertight integrity of the building. Pro-Bel roof mounted products are designed with a full understanding of reliable flashing/sealing techniques to satisfy virtually any roof condition.

Sole responsibility; Pro-Bel provides complete primary suspension and fall protection products/systems from concept to the supply and installation of same, including annual inspection.

Specific Liability insurance; all Pro-Bel monorail installations automatically carry \$5,000,000.00 + coverage against product/system failure (over 5000 projects successfully completed to date).

TYPICAL MONORAIL DETAILS

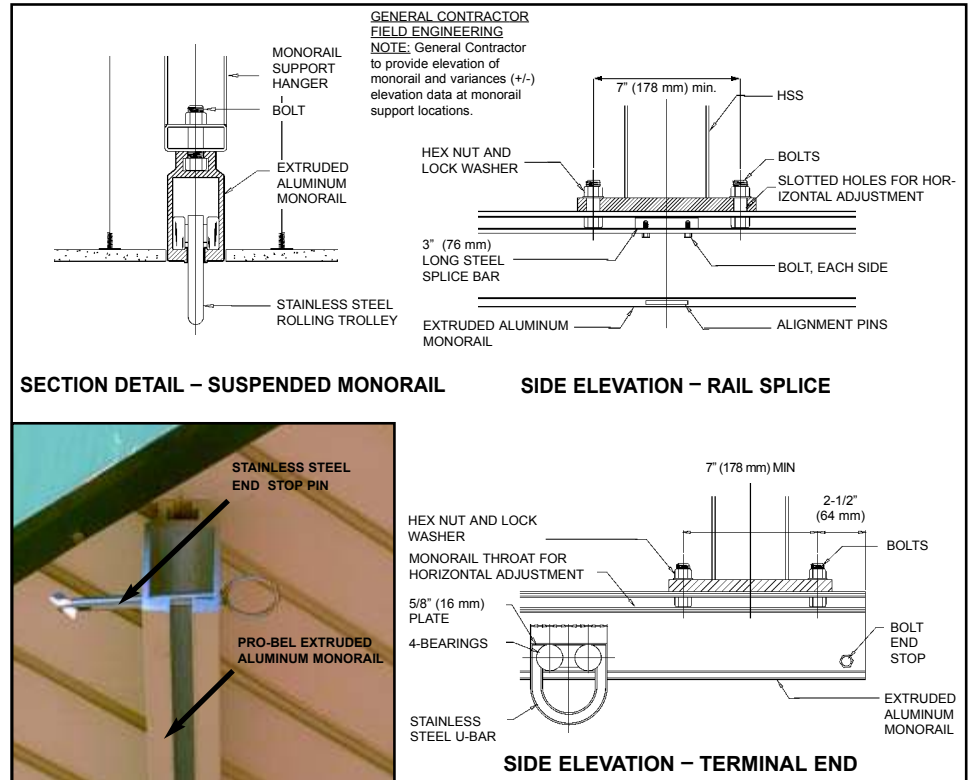

CLIMBING MONORAIL DETAILS

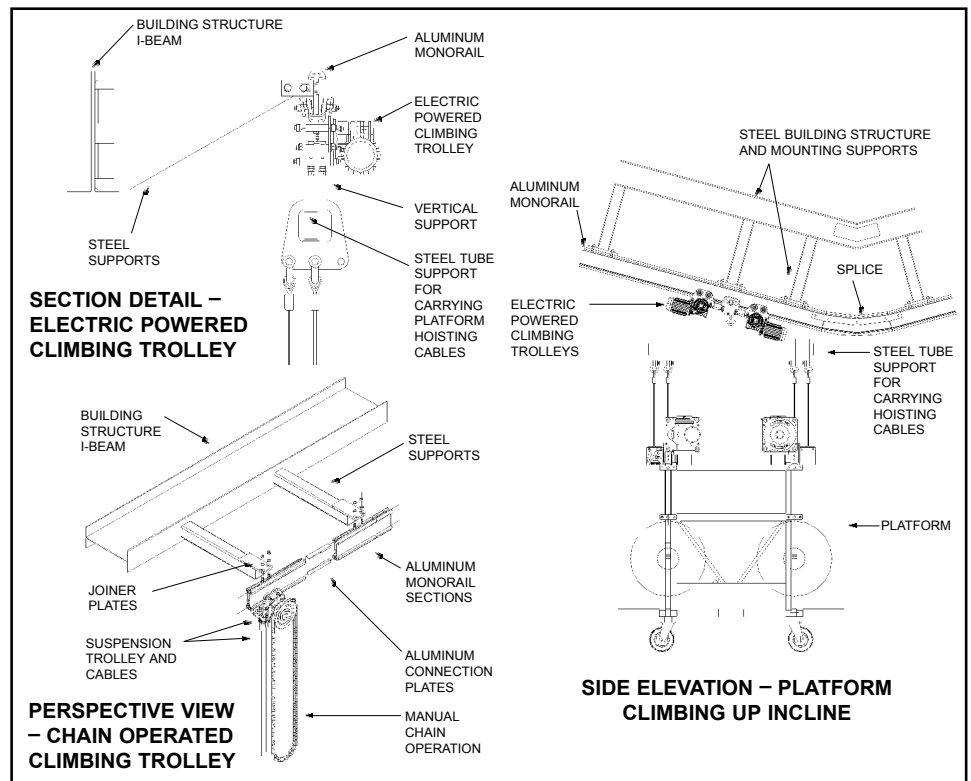

TYPICAL MONORAIL DETAILS (continued)

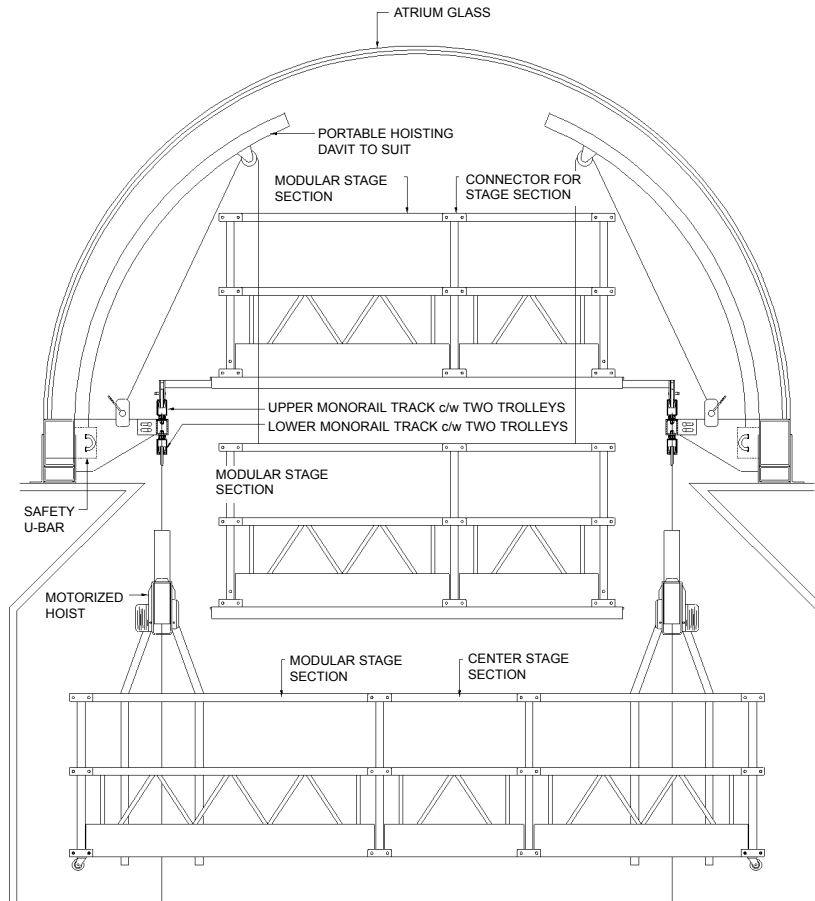

SECTION DETAIL AT ATRIUM – PRO-BEL DOUBLE (PIGGYBACK) MONORAIL SYSTEM

Recommended for use where window cleaning capability is required for atria having a curved upper (roof) atrium and lower (central court) atrium. Platform for court (using lower rails) can be converted or shortened at floor level and hoisted into upper space using davits, for use on upper rail. Monorails are extruded aluminum. G.O.B.C. Building, Public Works Canada, Halifax, Nova Scotia.

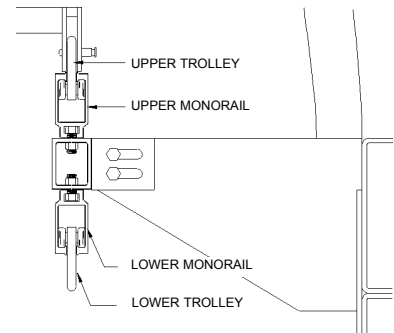

SECTION DETAIL – DOUBLE MONORAIL

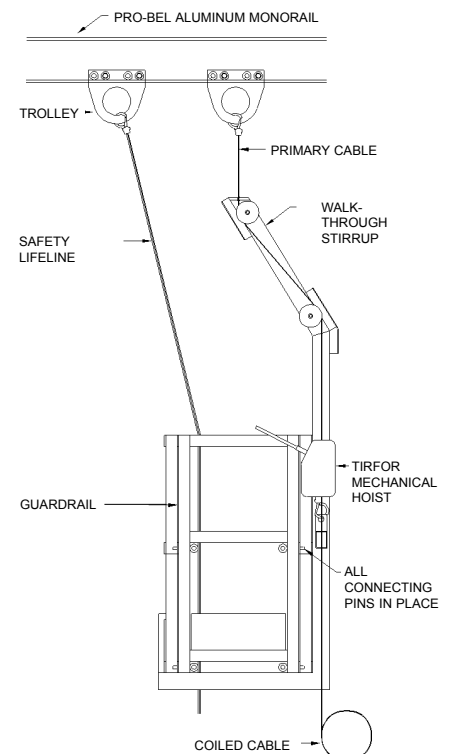

SIDE ELEVATION OF PLATFORM



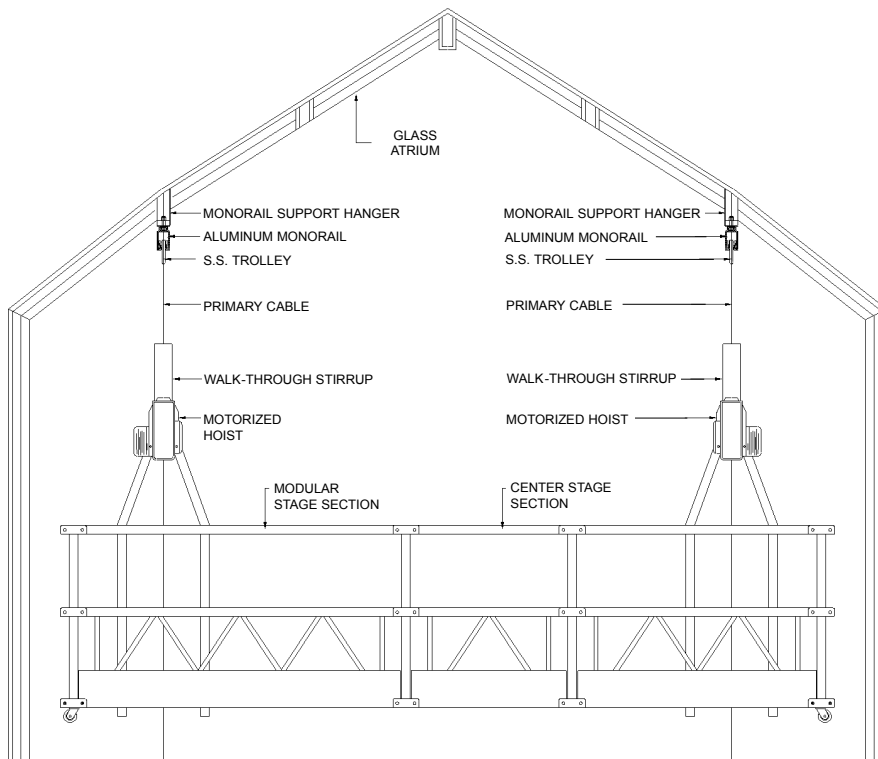

SECTION DETAIL AT ATRIUM – PRO-BEL SINGLE MONORAIL SYSTEM

Recommended for use in atria or sloped glazing/skylighting and soffit applications. For new or existing construction. Rails are extruded aluminum. Davisville Centre, Toronto, Ontario.



Localized operable window is used to access monorail for securing platform suspension lines.

MATERIALS/FABRICATION (as applicable)

Monorails: designed to carry minimum vertical service load of 1,000 lbs (4.5 kN); fabricated using aluminum extrusions to ASTM B221-2000 “Standard Specification for Aluminum and Aluminum-Alloy Extruded Bars, Rods, Wire, Profiles, and Tubes.”

or

Cold rolled hollow steel sections (HSS) with yield strength of 50 Ksi (350 MPa) and tensile strength of 65 Ksi (450 MPa), galvanized to ASTM A123/A123M-2002 “Standard Specification for Zinc Coating (Hot Dipped Galvanizing) of Iron and Steel Products.”

Note: Custom tubular, I-beam, or extruded aluminum monorails are also available.

Rail system entry points are equipped with prominently displayed, non-corrosive data plate clearly stating maximum service capacity.

Monorail supports, plate and all other sections: Galvanized mild steel, Type 300W with yield strength of 44 Ksi (300 MPa).

Trolleys: Type 304 stainless steel for exterior applications or powder coated mild steel for interior applications, with heavy duty rollers. Designed for straight or radiused rails.

Bolts, nuts and washers: Type 304 stainless steel or steel to ASTM A325.

Suspended Platform: Aluminum as per specifications.



This photo shows worker finishing ceiling around Pro-Bel monorail and corner-turning hub while working from a single work cage. The hub facilitates automatic turning at corners. Diplomat Hotel Resort, Hollywood, Florida.



Atrium showing perimeter *standard* monorail blending in with aluminum clad steel rafters. Separate monorail is located at ridge point. For window cleaning, platform can be suspended at any desired angle or height around all four sides of atrium glass. Beau Rivage Hotel, Biloxi, Mississippi.



Construction photo shows adjustable monorail hangers secured to steel rafters.



Adjustable monorail hanger, secured to structure above, allows for accurate leveling of rail.



Pro-Bel monorails are often installed in decorative ceilings. This curved monorail forms a complete circle. Salt Lake City Courthouse, Utah.



Monorail corner-turning hub secured to steel rafter provides automatic turning at corners. See worms-eye view on page M-9.

DESIGN CONSIDERATIONS

Point of suspension: arrange monorail or equipment layout to provide 24" (610 mm) distance between platform and face of glass. Soffits/ceilings must be hung independently to avoid potential for damage from deflection when rail is under load.

Suspension equipment access: ensure localized safe access to monorail via window, hatch, ladder, or rigging sleeve, including proper fall protection en route.

Rigging Sleeves: when rigging sleeves are required to access monorail to secure suspension lines, see Pro-Bel Rigging Sleeve Systems literature.

Highest level of suspension: to access uppermost part of area to be serviced or interior atrium windows, locate monorail at highest point of building.

Sloped interior glass access: in order to reach sloped glazing from a platform, consider a motorized climbing monorail system i.e. workers are able to follow slope and be within reach to service the glass. Note: When conventional platforms cannot be used or set up, a permanent interior gantry (platform on rails) must be considered.

Engineered glass: consider designing sloped atria glazing for walking on by window cleaning personnel using bosun's chair with descent control equipment in lieu of conventional transportable suspended equipment or permanent gantry.

Note: for typical sloped skylight atria where window cleaners need to walk on glass to access ridge points, install U-bar ridge anchors for securing suspension and lifelines. A special "Rope Installer" pole device is often used to thread lifelines through U-bar ridge anchors from a safe surface to gain access.

Access ladder or gantry: If it is necessary for window cleaners to avoid walking on glass, a removable aluminum ladder or permanent exterior gantry must be considered.

Concealed hanger locations: Maintenance access is required at all concealed

monorail supports. Special provisions e.g. access hatch, opening, etc., will need to be considered at soffits and similar areas in order to ensure that bolted securements can be inspected.



This exterior Pro-Bel aluminum concealed soffit monorail provides ease of access to the overhang area above for the glazing contractor. Soffits/ceiling must be hung independently to avoid potential for damage from deflection when rail is under load. Air Canada Centre, Toronto, Canada.



Construction photo shows interior atrium and how segmented monorail is used to provide turning radius for curved building applications (for suspended platform).



Close-up construction photo of curved monorail showing typical securement to building structure and turning radius at corners.

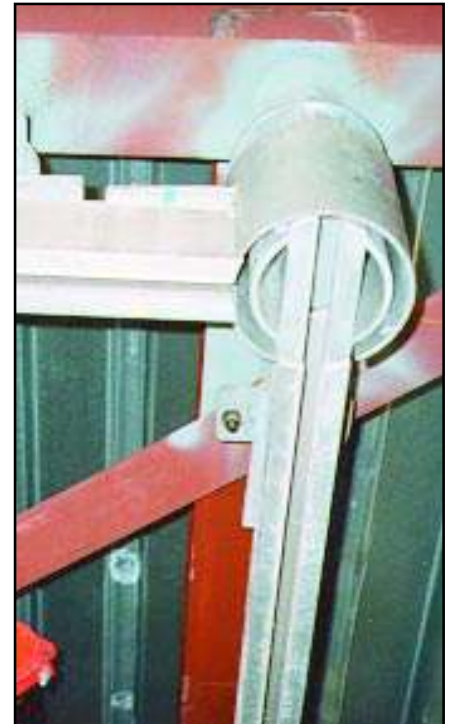

Looking up at corner of Pro-Bel segmented monorail going in two directions. Corner-turning hub permits automatic 90 degree turning of platform at corners where required.

MONORAIL LAYOUT PROCEDURE

1. Briefly review the Pro-Bel **System & Equipment Introduction literature (pages G-6 to G18)**. This data provides an overview of the various equipment options used to clean windows or perform other suspended building maintenance.
2. Identify all areas that require monorail access and mark locations on architectural plans.
3. Examine building elevations, various atrium floor plans, reflected ceiling plans or other drawings to identify any recesses or other unusual features.
4. Examine building section details to assess construction of atrium structure, parapet wall, soffit, exterior walls, roof and overhanging floor areas, or other building elements as necessary.
5. Examine roof or other type structural drawings for possible anchorage locations. Typically monorails, steel support piers, or similar devices are anchored to structural concrete walls or slabs, steel superstructure, or similar elements.
6. Determine where system entry and exit points are to be located e.g. at operable window, hatch, etc. and ensure that

personnel achieve 100% fall protection at all times while accessing these areas.

7. Locate monorail anchor points at 10'-0" to 12'-0" (3050 mm to 3658 mm) centers for the respective straight areas of monorail system selected. Arrange monorail or equipment to generally provide 24" (610 mm) distance between platform and face of glass or building. See also Design Considerations on page M-9 to assist in making a "rigging" decision.
8. Determine if radiused rails are required. Typically 90 or 45 degree bends require a 3'-0" (915 mm) minimum radius. Additional monorail supports are required at radii. Typically straight rails require 2 supports and all corner rails require a minimum of 3 supports.
9. Determine if rails are to be left exposed or concealed in soffit or ceiling spaces. Ensure that soffit or ceiling finish is independent of monorail.
10. In certain instances, it may be desirable or necessary to use other Pro-Bel products in conjunction with monorails. Examples include:
 - Rigging sleeves for accommodating safe access to monorail. See Pro-Bel

Rigging Sleeve Systems literature.

- U-bar safety (lifeline) anchors at interior operable window head to provide fall protection while accessing a monorail. See Pro-Bel Safety & Tie-Back Anchors literature.
- Davits for hoisting a platform into position to access monorail at atrium or other areas. See Pro-Bel Davit Systems literature.
- Gantries for use with tubular monorail systems, based on individual requirements.
- 11. If maintenance is to be performed using a temporary contractor supplied platform i.e. conventional equipment, as in the case of continuous windows or curtain wall, a "drop" for a platform is typically 20'-0" (6100 mm). Consider using smaller platforms with radiused monorail corner designs.
- 12. If maintenance is to be performed using a single work cage or bosun's chair, as in the case of occasional or sporadic windows, a "drop" for a chair is typically a 6'-0" (1830 mm) wide area and a cage is 8'-0" (2440 mm).

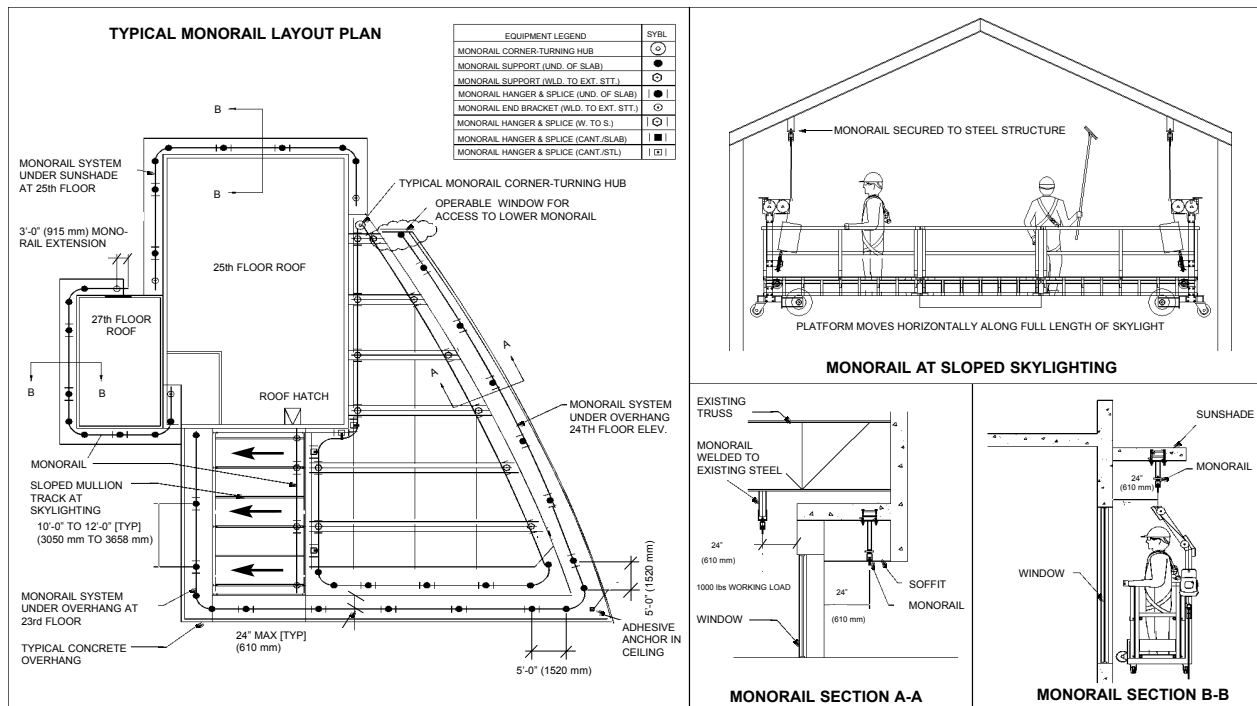

SPECIFICATION

SPEC NOTE: This basic guide specification (Section 11010 - Window Washing Systems) is devoted exclusively to monorails and related safety anchors and is written in accordance with the CSI/CSC Three Part Section Format. It must be adapted to suit the requirements of individual projects. If other equipment such as davits, outrigger beams, rigging sleeves, horizontal cable lifelines or other equipment is required, refer to appropriate Pro-Bel literature and incorporate materials and/or other clauses as required. Square brackets [] indicate choice, alternatives, data required or need for the specifier to make a decision.

PART 1 - GENERAL

1.01 General Requirements

- A. Comply with the conditions of the Contract and Division 1 - General Requirements.

1.02 Section Includes

- A. Work of this section includes the design, supply and installation of window cleaning/suspended maintenance equipment.

1.03 Related Sections

- A. Unloading and hoisting of equipment to roof
Section [01500]
- B. Cast-in-place concrete, including installation of embedded items
Section [03300]
- C. Precast concrete
Section [03400]
- D. Structural Steel
Section [05120]
- E. Open Web Steel Joists
Section [05210]
- F. Metal Deck
Section [05310]
- G. Catwalks
Section [05516]
- H. Roofing
Section [07500]
- I. Flashing
Section [07600]
- J. Sealants
Section [07900]
- K. Rigging access doors in walls
Section [08111]
- L. Continuous track stabilization on exterior of building
Section [08800]
- M. Installation of intermittent stabilization on exterior of building
Section [03450]
- N. Hot & Cold water supply, faucets and drain at [every] roof level
Section [15400]
- O. Three phase 208 volts, 60 Hertz service at [every] roof level
Section [16050]

SPEC NOTE: Re 1.03.P. Specify independent protected main line power and weatherproof Hubbell twist-lock 208 volts, 3 phase, 60 Hertz, 30 amperes receptacle (HBL2620SW, NEMA No. L6-30R for rental powered platforms). Power to be located no more than 100'-0" (30 m) from window cleaning/suspended maintenance equipment location. Outlets to experience no more than 3% voltage drop under full loading. Pro-Bel wall or roof anchors may be employed for strain relief. Contact Pro-Bel for requirements.

- P. Weatherproof power supply outlets with strain relief anchors
Section [16132]

1.04 References

- A. AISC S342L-1993, with Supplement No.1 "Load and Resistance Factor Design Specification for Structural Steel Buildings".
- B. AISI SG-971-1996, with 2000 Supplement "Spec-

ification for Design of Cold-Formed Steel Structural Members".

- C. Aluminum Association AA ADM-1-Aluminum Design Manual, 2000 and AWS D1.2-97 Structural Welding Code - Aluminum.
- D. AWS D1.1-2000 Structural Welding Code - Steel.
- E. ANSI/IWCA I-14.1-2001 Window Cleaning Safety Standard (International Window Cleaning Association).

1.05 Design Requirements

- A. Design window cleaning/suspended maintenance system to suit building and in accordance with plans, specifications, standards, and regulations/codes contained in section 1.04 and 1.08.

- B. Locate monorails to suit suspension equipment which will be used on the building with respect to items such as reach, rigging, spacing, roof edge condition and similar items.

- C. Design all anchor components to provide adequate attachment to the building and suited to current window cleaning/suspended maintenance practices. Ensure compatibility with industry standard equipment.

- D. Ensure all anchor components conform to proper engineering principles and have been designed by a Professional Engineer qualified in the design of window cleaning/suspended maintenance equipment, its application and safety requirements.

- E. Design system equipment supports and fall arrest safety anchors to comply with the following structural requirements:

1. Supports for Suspended Platforms: monorails are used for suspending a powered platform from storage and rigging/working locations on the building. These supports and the structure to which they are attached are typically designed to 1000 lbs (4.45 kN) vertical service load plus impact with a factor of safety as per AISC requirements and/or ACI or other applicable construction codes, and to 4 times the rated load against fracture or detachment (i.e. 4 to 1 stability factor).

1.06 Shop Drawings and Engineering Certification

- A. Submit shop drawings showing complete layout and configuration of complete window cleaning/suspended maintenance system, including all components and accessories. Clearly indicate design and fabrication details, window "drops", hardware, and installation details.

- B. Shop drawings to include installation and rigging instructions and all necessary Restrictive and Non-Restrictive Working Usage Notes and General Safety Notes.

- C. Shop drawings to be reviewed by a professional engineer, and upon request, complete with calculations or test reports.

1.07 Qualifications

- A. Manufacturer: Work of this Section to be execut-

ed by manufacturer specializing in the design, fabrication and installation of window cleaning /suspended maintenance systems having a minimum of 5 years documented experience.

- B. Loading and safety assurance: Work of this Section to meet the requirements of governing codes and jurisdiction and to comply with properly engineered loading and safety criteria for the intended use.

- C. Insurance: Manufacturer to carry specific liability insurance (products and completed operations) in the amount of \$5,000,000.00 + to protect against product/system failure.

- D. Welding to be executed by welders certified in accordance with AWS requirements.

1.08 Regulatory Requirements

SPEC NOTE: Re. 1.08, A. Specify for all States other than New York and California.

- A. Comply with the following OSHA regulations:
 1. 1910, Subpart D (Walking and Working Surfaces).
 2. Appendix C to 1910 (Personal Fall Arrest Systems).
 3. "OSHA Ruling on Window Cleaning by Bosun's Chair" Memorandum to Regional Administrators from P.K. Clark, Director, Directorate of Compliance Programs.
 4. 1910, Subpart F (Powered Platforms).

Spec Note: Re 1.08,B and 1.08,C. Specify for New York State or California only as applicable.

- B. Comply with the following New York State regulations:
 1. Department of Labor Advisory Standard 101 - Construction, Operation and Maintenance of Suspended Scaffolds Used for Window Cleaning and Light Maintenance.
 2. Advisory Standard 111 - Hoisting Machines Used for Suspended Scaffolds.
 3. Department of Labor Industrial Code Rule 21 - Protection of Persons Employed at Window Cleaning - Structural Requirements, Equipment and Procedures.

- C. Comply with the following California State regulation:
 1. Code of Regulations, Title 8 - Industrial Relations, Article 5 (Window Cleaning), Article 6 (Powered Platforms for Exterior Building Maintenance), and Appendix C to Article 6 (Personal Fall Arrest System).

1.09 Maintenance Data

- A. Submit 1 copy of system Equipment Manual & Inspection Log Book, with "Initial Inspection - Certification for Use" and "Inspection Sign-Off" forms completed.

- B. Submit 2 copies of a reduced plastic laminated as-built shop drawing showing equipment locations and details. This drawing is to be posted near exits onto the roof.



Monorail Systems Specification (continued)

PART 2 - PRODUCTS

2.01 Manufacturer

- A. This specification is based on systems currently being manufactured by PRO-BEL ENTERPRISES LTD...
B. Other manufactured products meeting this specification may be substituted provided that manufacturers show proof of product insurance.

2.02 Equipment

Spec Note: List type and quantity as required. Material clauses for electric powered climbing monorail trolleys are not included here as their use in projects is unusual.

- A. []
B. []
C. []

2.03 Materials

SPEC NOTE: Delete items not required.

- A. Monorails and mounting: designed to carry minimum vertical service load of 1,000 lbs (4.5 kN)
B. Monorail finish: exterior finish to be [mill] [anodized] [galvanized]
C. Capacity/Data plates: rail entry systems to be equipped with prominently displayed, non-corrosive plate
D. Trolleys: equipped with heavy duty rollers and

5/8" (16 mm) diameter U-bar eye; finish to be [Type 304 stainless steel.] [powder coated mild steel to match monorail.]

- E. Safety U-bars: [Type 304 stainless steel with yield strength of 35 Ksi (240 MPa)] [mild steel, Type 300W with yield strength of 44 Ksi (300 MPa), hot-dip galvanized to ASTM A123/A123M-2002].
F. Securement bolts: mild steel, Type 300W with yield strength of 44 Ksi (300 MPa), hot-dip galvanized to ASTM A123/A123M-2002.
G. Hollow steel section (HSS) piers: galvanized steel as above with yield strength of 50 Ksi (350 MPa).
H. Tethers: All pins and loose pieces to be secured using 1/8" (3 mm) stainless steel cable complete with easily inserted lead connectors to avoid loss.
I. Plate and all other sections: galvanized mild steel as above with yield strength of 44 Ksi (300 MPa).

SPEC NOTE: Re 2.03.J. Specify aluminum flashing for BUR or modified bitumen roofs only (membrane above or below insulation). For single ply roofs, flashing to be in accordance with membrane manufacturer's instructions.

- J. Seamless spun aluminum flashing (for roof mounted steel pier anchors): Type 6061-T6 alloy to ASTM B221-2000 with deck flange flashed in to NRCA or CRCA recommendations.
K. Miscellaneous bolts, nuts and washers: mild steel, Type 300W with yield strength of 44 Ksi (300 MPa), hot-dip galvanized to ASTM A123/A123M-2002 or Type 304 stainless steel with yield strength of 35 Ksi (240 MPa).

2.04 Fabrication

- A. General:
1. Fabricate work true to dimension, square, plumb, level and free from distortion or defects detrimental to appearance and performance.
2. Grind off surplus welding material and ensure exposed internal corners have smooth lines.
B. Monorails:
1. Design trolleys to run freely under load with minimum discontinuity at rail splices.
2. Provide end stops to ensure trolleys cannot become detached from the rail.

PART 3 - EXECUTION

3.01 Examination

- A. Examine surfaces and areas upon which the work of this Section depends. Report to the Contractor in writing, defects of work prepared by other trades and other unsatisfactory site conditions which would cause defective installation of products, or cause latent defects in workmanship and function.
B. Verify site dimensions.
C. Commencement of work will imply acceptance of prepared work.

3.02 Installation

- A. Install equipment in accordance with approved shop drawings and manufacturer's recommendations.
B. Co-ordinate installation with work of related trades.
C. General Contractor to provide elevation of monorail and variances in structure (+/-) elevation data at monorail support locations.
D. Install all work true, level, tightly fitted and flush with adjacent surfaces as required.

SPEC NOTE: Re 3.02.D. Specify for furnish only projects if required.

- E. Manufacturer to assist and/or supervise installation of window cleaning/suspended maintenance equipment installed by others.
F. Structural steel to receive monorail supports/anchors to have adequate bearing surface as indicated on shop drawings and/or to ensure 100% weld.
G. Deform threads of tail end of anchor studs and monorail support bolts after nuts have been tightened to prevent accidental removal or vandalism.

SPEC NOTE: Access hatches or openings are required for the inspection of concealed monorail supports.

3.03 Final Adjusting and Inspection

- A. Adjust and leave equipment in proper working order.
B. Complete "Initial Inspection - Certification for Use" form included in Equipment Manual & Inspection Log Book.

3.04 Testing

- A. All anchorage systems relying upon chemical adhesive fasteners to be 100% tested on site using load cell test apparatus in accordance with manufacturer's recommendations.

SERVING U.S.A. AND CANADA, COAST TO COAST.

PRO-BEL ENTERPRISES LIMITED

Head Office
765 Westney Road S,
Ajax, ON CA L1S 6W1
[t] 905.427.0616
[tf] 1.800.461.0575
[f] 905.427.2545
[e] info@pro-bel.ca

Western Office
#103-350, East Kent Ave S
Vancouver, BC V5X 4N6
[t] 604.687.1301
[f] 604.687.1306
[e] infovan@pro-bel.ca

Pro-Bel USA
#29320 Union City Blvd.
Union City, CA 94587 USA
[t] 510.477.9666
[tf] 1.866.577.6235
[f] 510.477.9555
[e] info@pro-belusa.com

PRO-GRESS • PRO-BEL

www.pro-belusa.com
www.pro-bel.ca